

IMPACT ACOUSTIC®

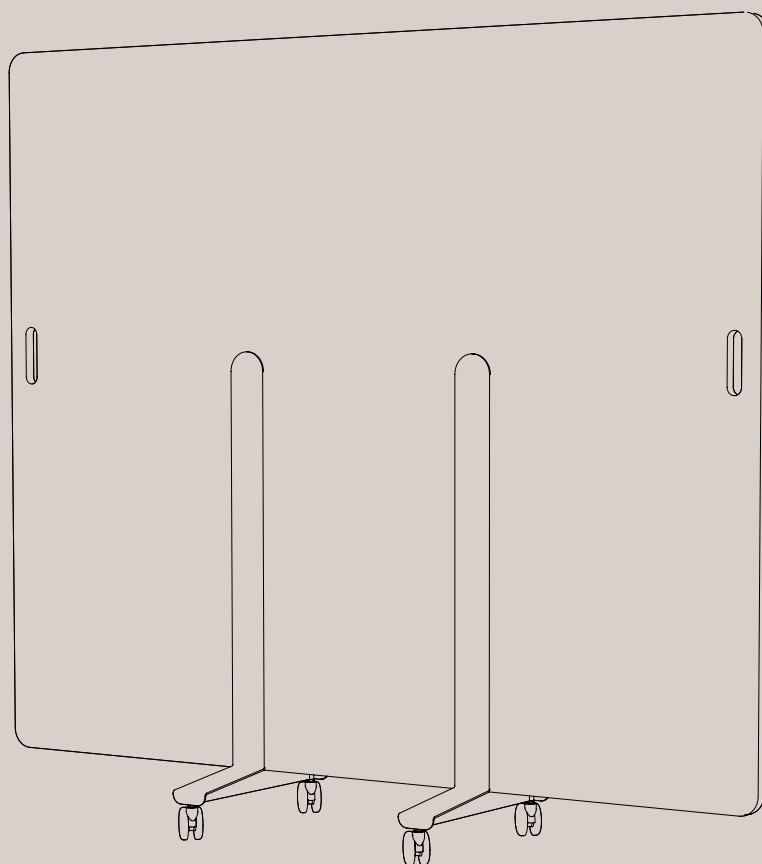

Motus

Standing Partition

744.24.10.000.00

744.24.11.000.00

TECHNICAL DATA SHEET

Motus Standing Partition

General Information



Data

Applicable article numbers

744.24.10.000.00 744.24.11.000.00

Dimensions ¹	Small		Big	
Height	1600 mm	63.00"	1800 mm	70.86"
Width	1800 mm	70.86"	1800 mm	70.86"
Panel thickness	24 mm	0.94"	24 mm	0.94"

Material

PET Panel	100% PET (60% post-consumer) in 32 colors	
Stand legs	Steel (powder coated black)	
Casters	Polyamid / Thermoplastic rubber	

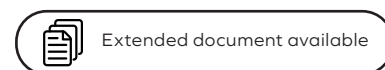

Weight²

PET Panel	4kg/m ² (±10%)	0.82 lbs/ft ² (±10%)
Stand legs	10kg	22 lbs

Included

Acoustic panel

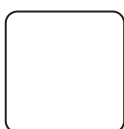

Stand legs (2x) and casters (4x)

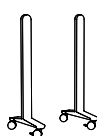

Assembly guide



Warranty 2 years³



1 - all dimensions are nominal 2 - all weight values are nominal 3 - Impact Acoustic warranty terms apply

Motus Standing Partition

Specification Guide

Ensure you make the perfect choice by choosing our solutions for your next project. Explore our range of standard solutions or contact us directly for a more in-depth discussion of personalised customized options.

1 Specify your product:

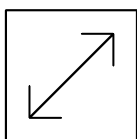

Size
page 4 and 6



Color
page 9

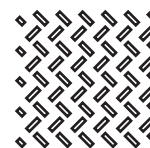

Pattern
page 5 and 7

2 Article numbers:

Item	Material	Size option	Color	Pattern
744	24mm	Choose size as shown on p. 6	Choose color as shown on p. 8	Choose pattern as shown on p. 5

Example: 744.24.10.662.10

Standing Partition - Motus, 24mm, 1600x1800 662 - Poster Red - Web Pattern

Motus Standing Partition

Geometry Information

Motus Standing Partition Plain 744.24.10.000.00

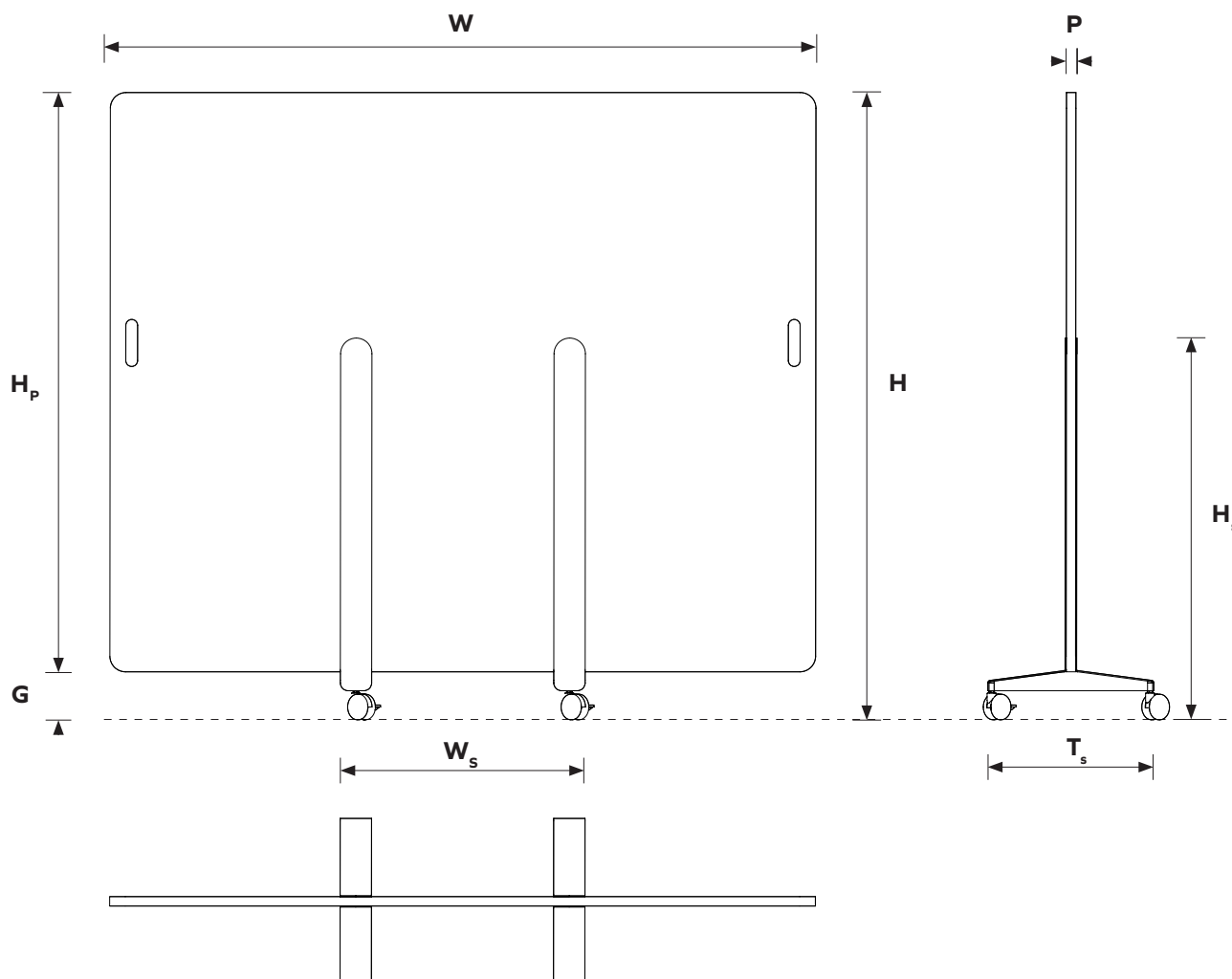

Dimensions table¹

W	Total width	1800mm	70.87"
H	Total height	1600mm	63.00" <i>including casters</i>
H_p	PET Panel height	1478mm	58.19"
H_s	Stand height	974mm	38.35" <i>including casters</i>
W_s	Stand width	625mm	24.60"
T_s	Stand thickness	423mm	16.65" <i>excluding casters</i>
G	Gap from the ground	122mm	4.80"
P	PET Panel thickness	24mm	0.94"

1 - all dimensions are nominal

Motus Standing Partition

Available perforations

Please note that all patterns are available in six sizes. See next page for sizes options.

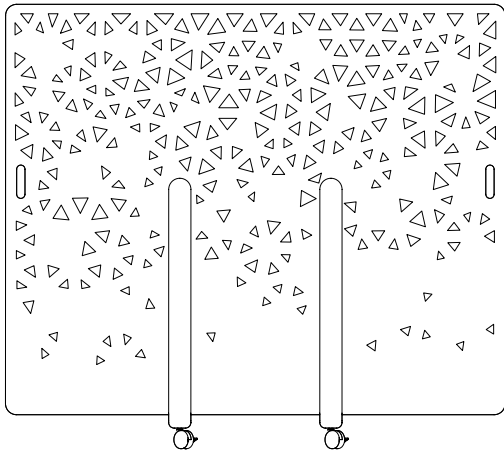

744.24.10.000.10 - Motus Standing Partition Web

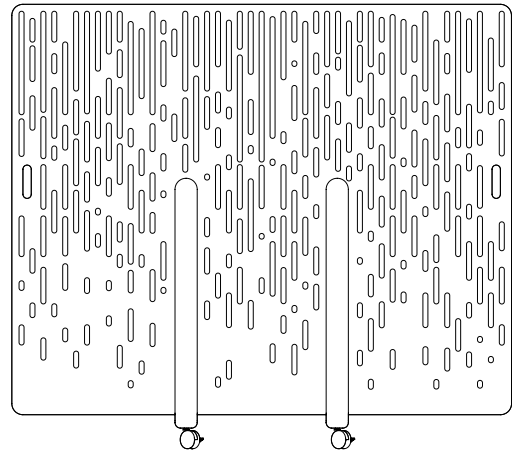

744.24.10.000.11 - Motus Standing Partition Matrix

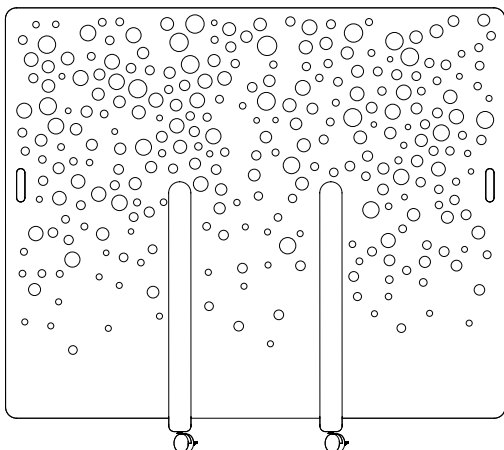

744.24.10.000.12 - Motus Standing Partition Bubbles

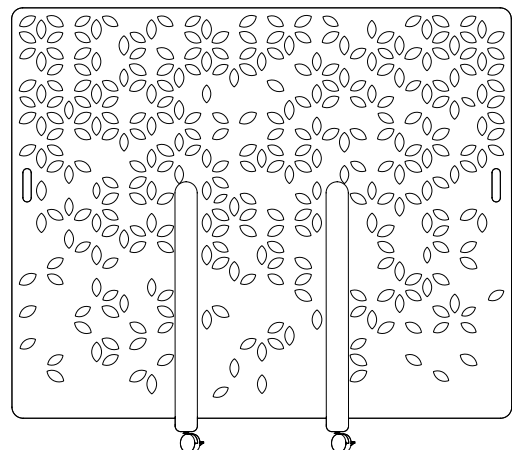

744.24.10.000.13 - Motus Standing Partition Crose

Motus Standing Partition

Geometry Information

Motus Standing Partition Plain 744.24.11.000.00

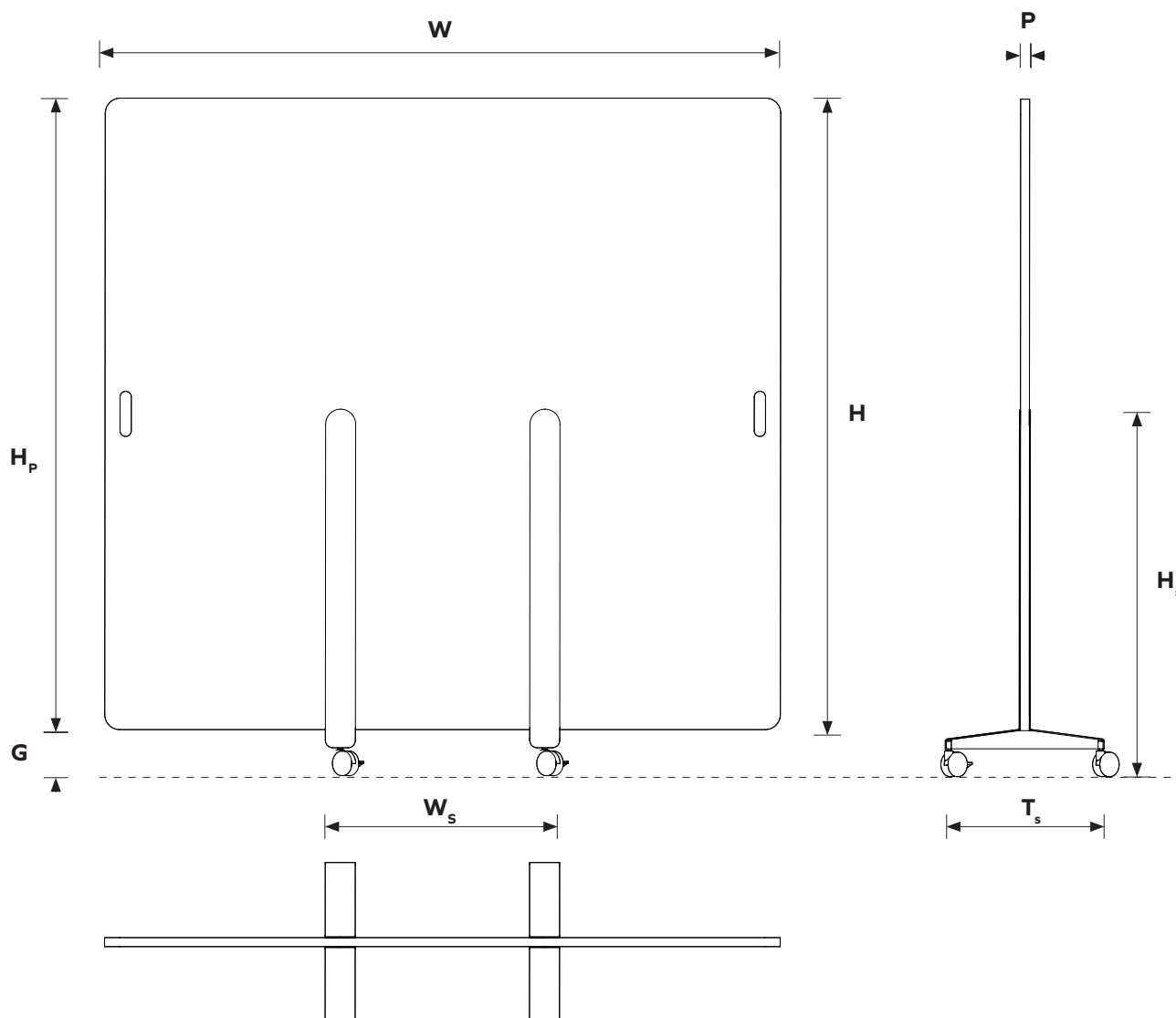

Dimensions table¹

W	Total width	1800mm	70.87"
H	Total height	1800mm	70.87" <i>including casters</i>
H_p	PET Panel height	1678mm	66.06"
H_s	Stand height	974mm	38.35" <i>including casters</i>
W_s	Stand width	625mm	24.60"
T_s	Stand thickness	423mm	16.65" <i>excluding casters</i>
G	Gap from the ground	122mm	4.80"
P	PET Panel thickness	24mm	0.94"

1 - all dimensions are nominal

Motus Standing Partition

Available perforations

Please note that all patterns are available in six sizes. See next page for sizes options.

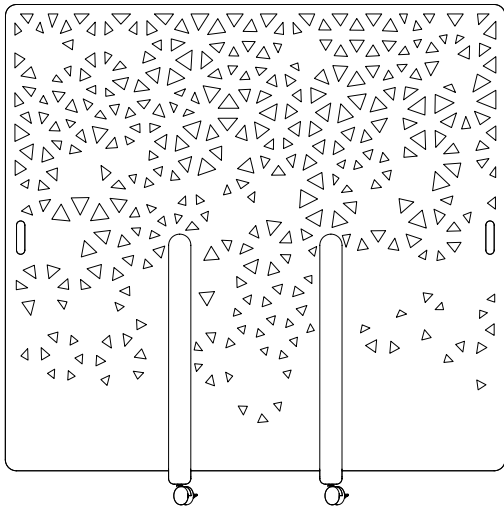

744.24.11.000.10 - Motus Standing Partition Web

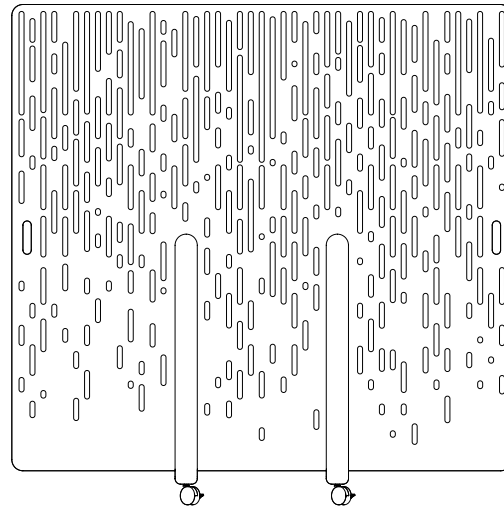

744.24.11.000.11 - Motus Standing Partition Matrix

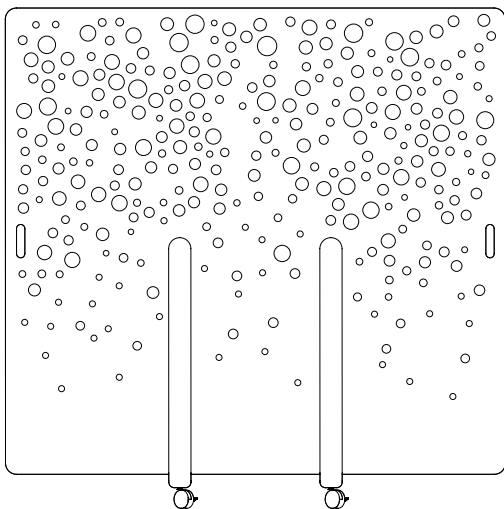

744.24.11.000.12 - Motus Standing Partition Bubbles

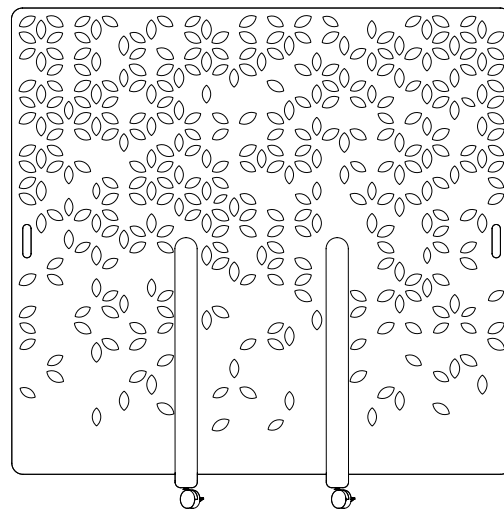

744.24.11.000.13 - Motus Standing Partition Crose

Motus Standing Partition

Assembly overview

1 Stand legs

Place the stand legs on even horizontal surface and space them to match the incision cuts on the panel.

2 PET Acoustic Panel

Slide the acoustic panel into the stand legs as much as possible.

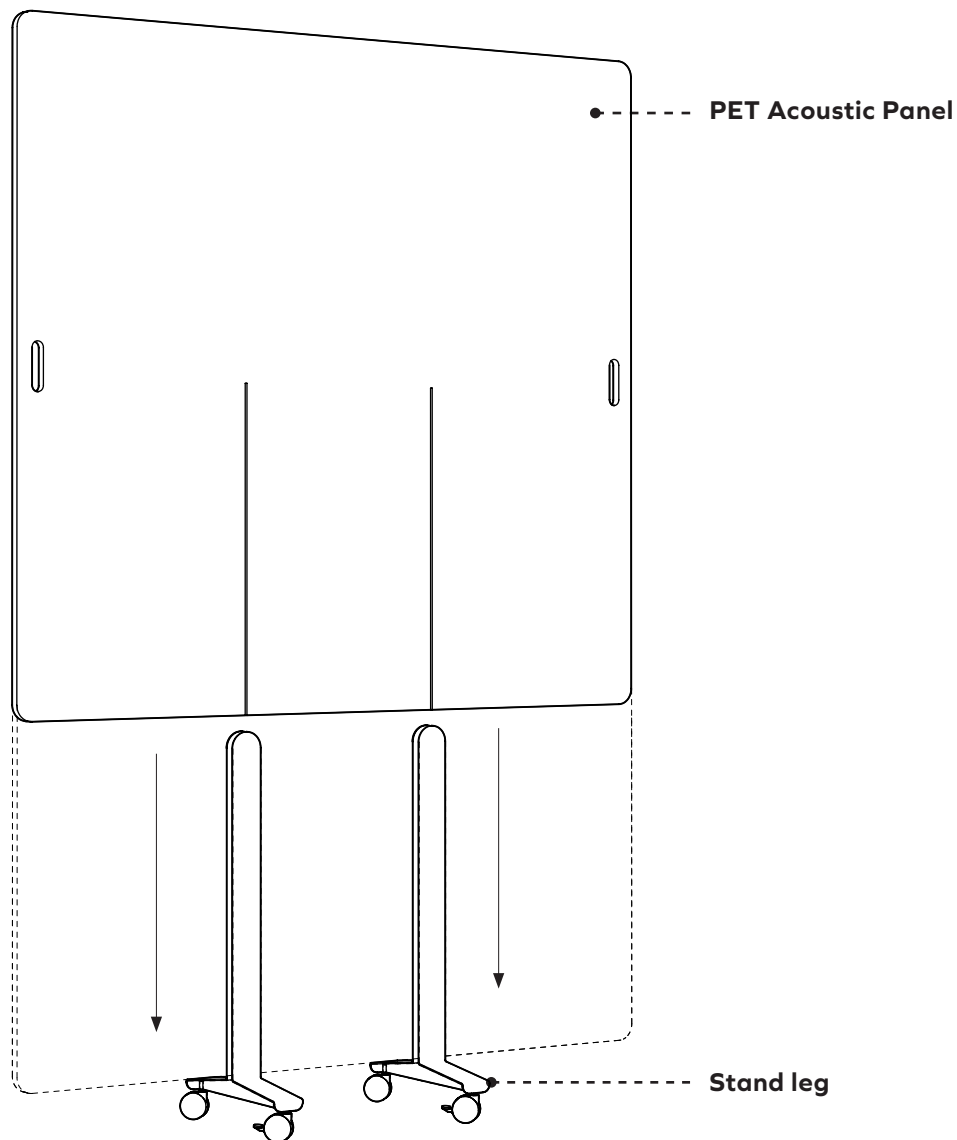

ARCHISONIC®

Colors

 Material brochure available



Name	Snow White	Milk	Cloud	Smoke	Ground	Charcoal	Slate	Raven
Color Code	500	404	103	442	108	542	444	550
NCS Code	S 0300-N	S 0502-Y	S 1002-B	S 3005-R80B	S 5005-Y20R	S 7502-B	S 4500-N	S 8500-N



Name	Nordic Pine	Grove	Moss	Spearmint	Ice Blue	Succulent	Deep Sea	Marine Blue
Color Code	311	317	439	706	304	712	918	864
NCS Code	S 5030-G10Y	S 7020-G30Y	S 2040-G40Y	S 1010-B90G	S 0510-B	S 3020-B30G	S 5020-R90B	S 4050-R70B



Name	Linen	Shell Pink	Jute	Warm Stone	Terracotta	Soft Coral	Honeycomb	Sunshine
Color Code	107	102	920	105	239	516	139	846
NCS Code	S 1505-Y30R	S 0510-R30B	S 3010-Y30R	S 3010-Y50R	S 4040-Y70R	S 2020-Y90R	S 2050-Y20R	S 1040-Y10R



Name	Garnet	Hot Pink	Poster Red	Electric Orange	Winter Sky	Pacific Ocean	Midnight	Grape
Color Code	724	140	662	464	311	432	810	540
NCS Code	S 5040-R10B	S 2060-R20B	S 1080-R	S 0580-Y70R	S 5030-G10Y	S 3040-B	S 7020-R70B	S 5040-R40B

These NCS codes are the closest visual match available and may not be exact to blended fibres.

ARCHISONIC®

Colors

Experience our ARCHISONIC® Felt material with a stunning selection of 32 colors across 8 distinct families, thoughtfully curated by *Colour Hive* in London. Effortlessly combine colors harmoniously to suit your preferences. Discover more in our Materials brochure and order your free sample box today.

Color fastness

Class 6

ISO 105-B02:A1

Order a free sample box



ARCHISONIC® Felt

Material Specification

Product Name	Archisonic® Felt	
Content	100% PET (60% certified post-consumer content)	
Thickness¹	12mm (0.47")	24mm (0.94")
Max. Size	1200x2800mm (47"x110")	1800x2400mm (70"x94")
Acoustic²	ASTM: NRC=0.6 ISO: α_w =0.65	ASTM: NRC=0.9 ISO: α_w =0.95
Density¹	2400 g/m ² (0.49 lbs/ sqft)	4000 g/m ² (0.82 lbs/sqft)
Color Fastness	Class 6 ISO 105-B02:A1	
Color	32 colors (see Archisonic® Felt Color page for more information)	
Maintenance	For daily cleaning we recommend alcohol solution (75%), e.g. Pantasept. In case of contamination by dust or fluff, use feather duster or a regular vacuum cleaner. For heavy dirt, treat the material with hydrogen peroxide.	
Lead time³	21 days	
Fire Rating	DIN EN 13501-1: B-s1, d0	ASTM E84 Class A
VOC Emission	28 Days French Regulation A+ ASTM E84 Pass Bream® (International, UK, NL, SE, NOR) Exemplary CDPH (CDPH/EHLB/Standard Method V1.2) Pass	
Certifications	Declare label, Cradle to Cradle, UL Environmental Product Declaration, Member of US Green Building Council, Ecobau 1st Priority, Climmate-KIC, VOC emissions in LEED EQ credit (low-emitting products), SCS Recycled Content	
Durability	Contract	

1 - all values are nominal 2 - measured with 300mm air cavity 3 - depending on the location and type of product



Climate-KIC is supported by the EIT, a body of the European Union



Declare.



Asto Standing Division

Acoustic Performance

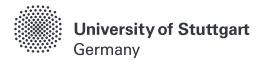

Testing Standards

ISO 354:2003	Acoustics — Measurement of sound absorption in a reverberation room
ISO 11654:1997	Acoustics — Sound absorbers for use in buildings — Rating of sound absorption
ISO 20189:2018	Acoustics — Screens, furniture and single objects intended for interior use — Rating of sound absorption and sound reduction of elements based on laboratory measurements
ASTM C423-17	Standard Test Method for Sound Absorption and Sound Absorption Coefficients by the Reverberation Room Method
ASTM E795-16	Standard Practices for Mounting Test Specimens During Sound Absorption Tests

Acoustic Test Results

	α_w	SAA	NRC
24mm Wall Panel 1800x2400mm (Plain)	0.55 (H)	0.57	0.55
24mm Wall Panel 1800x2400mm (Perforated pattern)	0.45 (H)	0.47	0.45
12mm Wall Panel 1200x2800mm (Plain)	0.4 (H)	0.39	0.40
12mm Wall Panel 1200x2800mm (Perforated pattern)	0.35 (H)	0.32	0.35

Measurement used Pink Noise as excitation signal in a reverberant room.

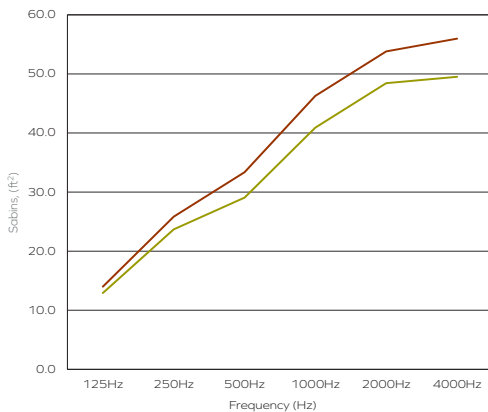

Acoustic Performance - ASTM Sabins , ft²

Frequency (Hz)	125	250	500	1000	2000	4000
24mm Motus 1800mm x 1600mm	12.92	23.68	29.06	40.90	48.44	49.51
24mm Motus 1800mm x 1800mm	13.99	25.83	33.37	46.28	53.82	55.97

The graph represents the Sabins (ft²) in the third octave band center frequencies.

- 24mm Motus 1800mm x 1600mm
- 24mm Motus 1800mm x 1800mm

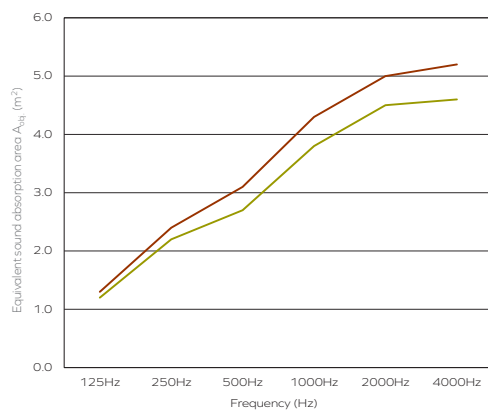

Acoustic Performance - ISO A_{obj} , m²

Frequency (Hz)	125	250	500	1000	2000	4000
24mm Motus 1800mm x 1600mm	1.2	2.2	2.7	3.8	4.5	4.6
24mm Motus 1800mm x 1800mm	1.3	2.4	3.1	4.3	5.0	5.2

The graph represents the equivalent sound absorption per object (A_{obj}) in the third octave band center frequencies.

- 24mm Motus 1800mm x 1600mm
- 24mm Motus 1800mm x 1800mm

Please note this data refers only to the plain option. Acoustic performance of the perforated panels is available upon demand.

Motus Standing Partition

Additional Information

Online Resources

A variety of resources are available online for all of our products. Please visit the product's page for more information.



CAD files



Spec sheets and
Installation Guide



Color families



Instruction
videos



Associated
products specs.

Ordering Process

Our experienced team of Project Consultants will guide and support you throughout the order process. We fulfill the majority of our orders in as little as 21 days¹ from your first point of contact, allowing you to focus on what truly matters to you.



Contact our
consultant

Quote¹

48 h



Order Confirmation

Production¹

2 - 3 weeks



Dispatch

Transit

location based



Delivery

Contact Us

Ready to make an impact? We are just an email or call away to discuss your project and answer any question.



+41 41 566 55 55



connect@impactacoustic.com



Online form

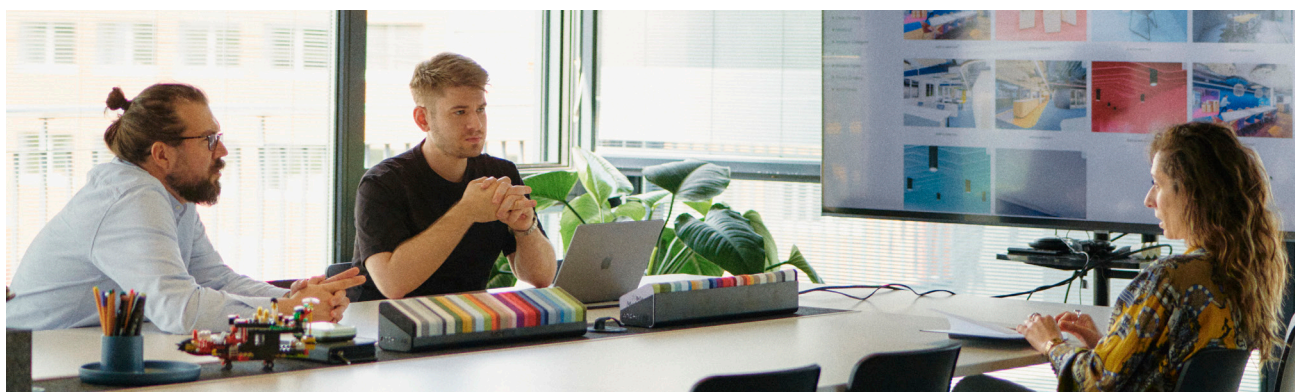

¹ - Quote and Production times may vary.

IMPACT ACOUSTIC®
Motus Partition rev.01 - 14.12.23

(Switzerland)
(USA)
(Philippines)

connect@impactacoustic.com
usa@impactacoustic.com
philippines@impactacoustic.com

(+41) 41 566 55 55
(+1) 646 918 1581
(+63) 285 80 02 50

#WeMakeAnImpact

**#We
Make An
Impact**

connect@impactacoustic.com | www.impactacoustic.com