

IMPACT ACOUSTIC®

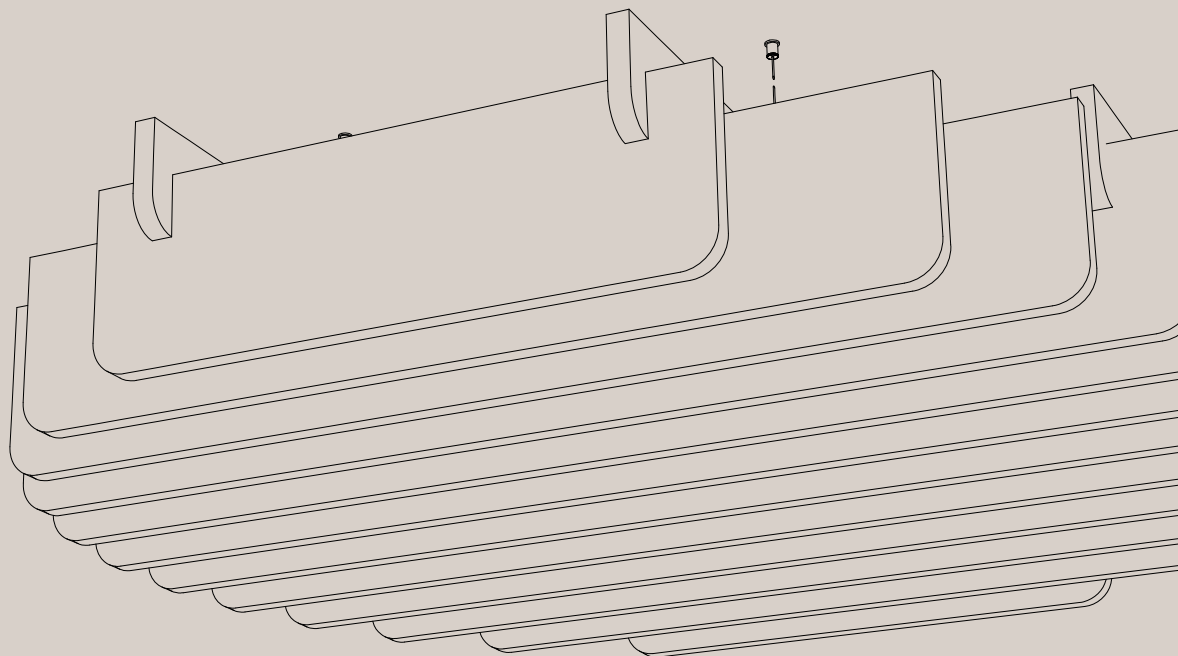

Nebula

Modular Baffle

712.24.14.000.00
712.24.15.000.00

TECHNICAL DATA SHEET

Nebula Modular Baffle

General Information

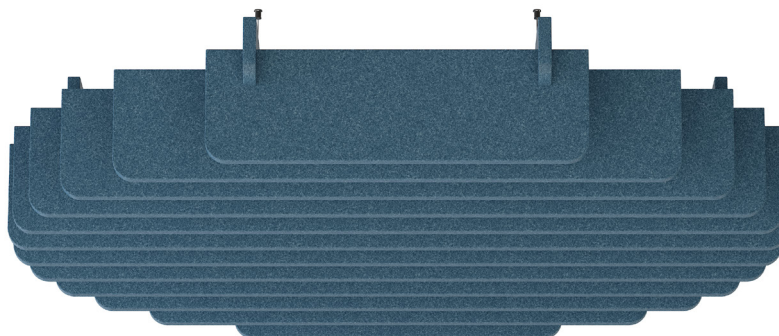

Data

Applicable article numbers

712.24.14.000.00 712.24.15.000.00

Dimensions¹

Width	1100 or 1476mm	43.3" or 58.11"
Length	1060 or 1535mm	41.73" or 60.43"
Material thickness	24mm	0.94"
Total Height	285 and 262mm	on demand

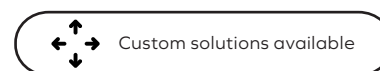

Material

Baffles	100% PET (60% post-consumer) in 32 colors.
Gripper system	Stainless steel

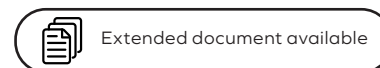

Weight²

712.24.14.000.00	7.68 kg (±10%)	16.93 lbs (±10%)	(without suspension)
712.24.15.000.00	14.52 kg (±10%)	32.01 lbs (±10%)	(without suspension)

Included

Baffle Module

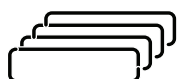

Cable-Gripper
Suspension



Installation
guide



Warranty
2 years³



1 - all dimensions are nominal 2 - all weight values are nominal 3 - Impact Acoustic warranty terms apply

Nebula Modular Baffle

Specification Guide

Ensure you make the perfect choice by choosing our solutions for your next project. To get started, simply define some basic information and constraints about your space. Then explore our range of standard solutions or contact us directly for a more in-depth discussion of personalised customized options.

1 Prepare this information:

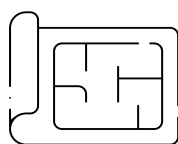

Ceiling Plans (RCP)

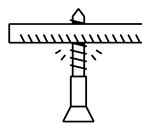

Ceiling Type

2 Specify your Baffles:

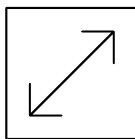

Size

page 5 and 6

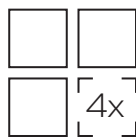

Number of Modules

page 4

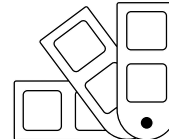

Color

page 8

3 Verify installation method:

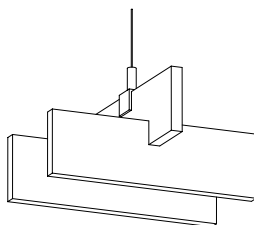

Gripper + Slotted
Baffle

page 7

Nebula Modular Baffle

Product Family Overview

1 Nebula Modular Baffle Small

712.24.14.000.00 - Ceiling Baffle Nebula Modular

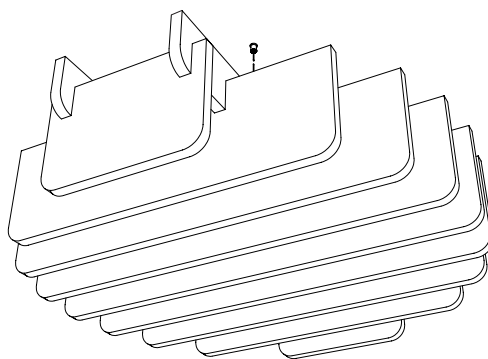

(W1100 L1060, H285)
(W43.31" L41.73" H11.22")

2 Nebula Modular Baffle Big

712.24.15.000.00 - Ceiling Baffle Nebula Modular

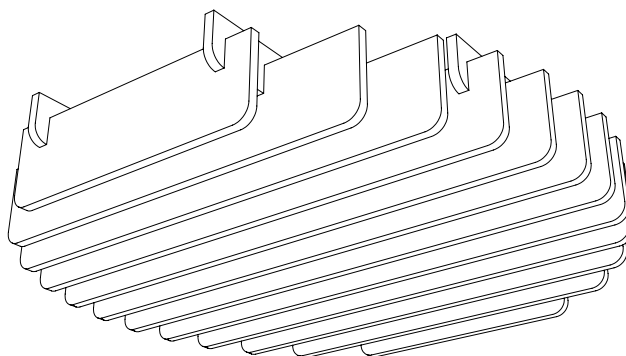

(W1476 L1535, H262)
(W58.11" L60.43" H10.32")

Nebula Modular Baffle

Geometry Information

Custom solutions available

Ceiling Baffle Nebula Modular 712.24.14.000.00

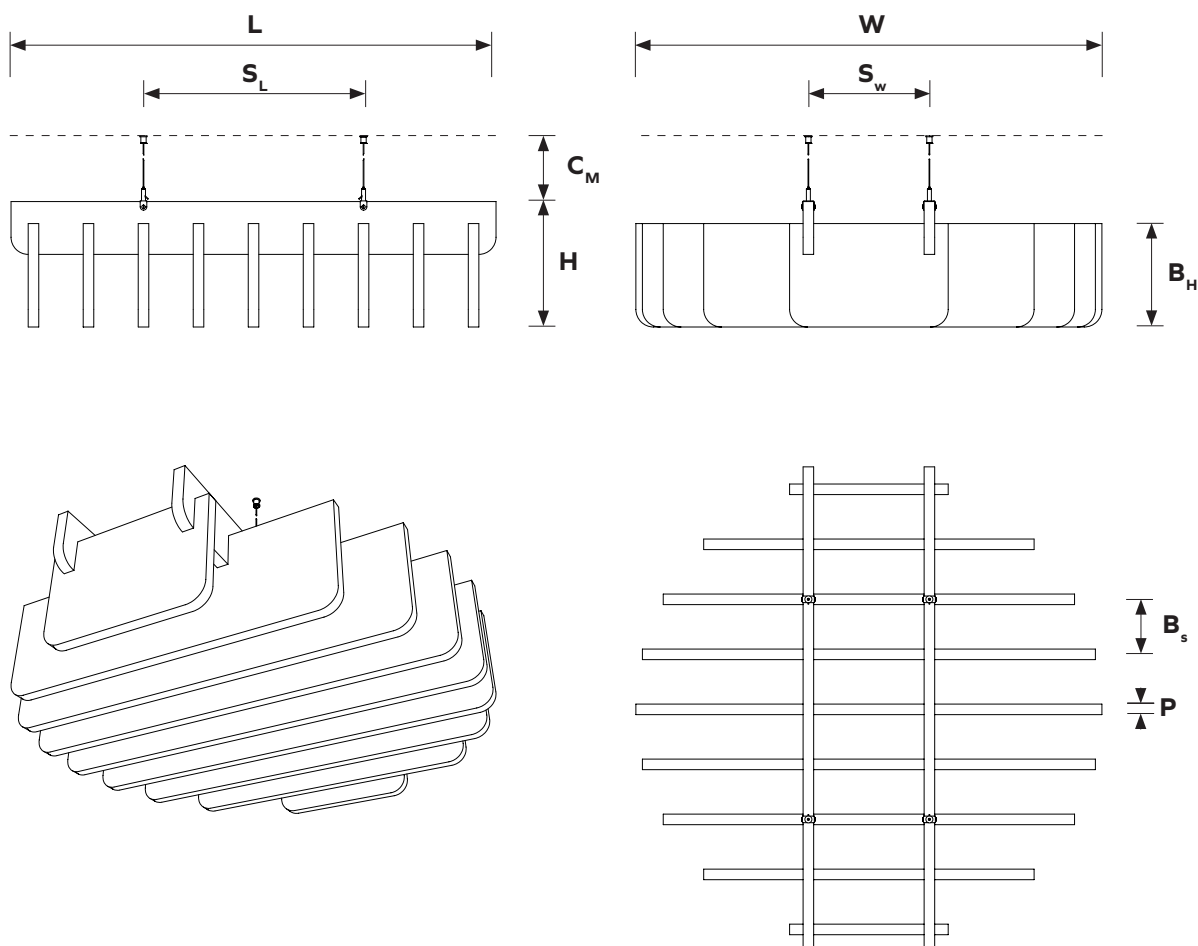

Dimensions table

W	Total width	1100mm	43.3"
L	Total length	1060mm	41.73"
H	Total height	285mm	11.22"
B_H	Bottom baffle height	235mm	9.25"
B_S	Baffle spacing	125mm	4.92"
C_M	Min. distance from ceiling	min. 100mm	min. 4"
S_W	Support spacing W	500mm	19.68"
S_L	Support spacing L	275mm	10.83"
P	PET material thickness	24mm	0.94"

Nebula Modular Baffle

Geometry Information



Ceiling Baffle Nebula Modular 712.24.15.000.00

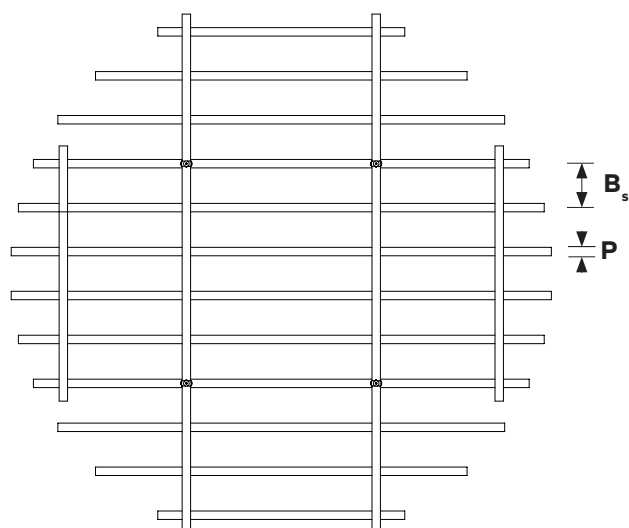
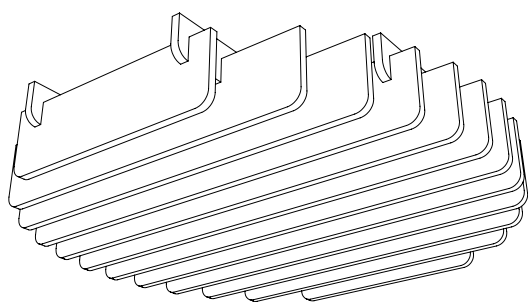
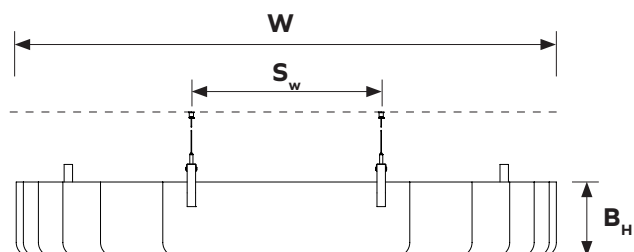
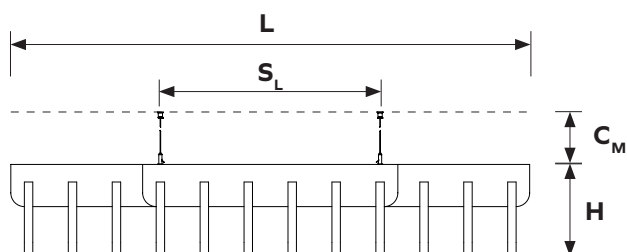

Dimensions table

W	Total width	1476mm	58.11"
L	Total length	1060mm	60.43"
H	Total height	262mm	11.22"
B_H	Bottom baffle height	235mm	10.32"
B_s	Baffle spacing	125mm	4.92"
C_M	Min. distance from ceiling	min. 100mm	min. 4"
S_w	Support spacing W	540mm	21.26"
S_L	Support spacing L	625mm	24.61"
P	PET material thickness	24mm	0.94"

Nebula Modular Baffle

Installation Overview

 Extended document available

1 Attach mounting hardware

Attach 4 pieces of mounting cables (1) to the ceiling.

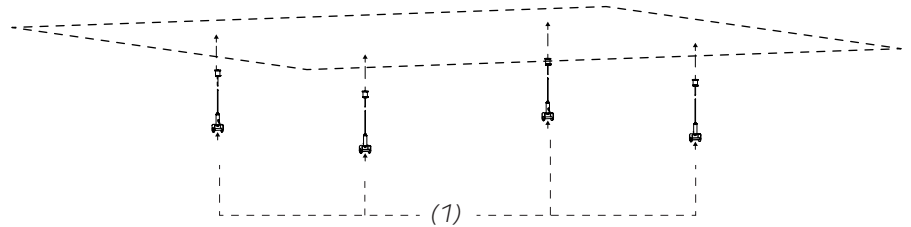

2 Install upper Baffles

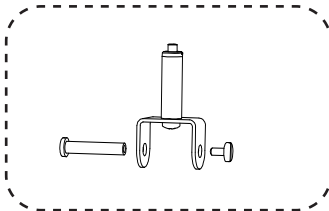

Attach slotted upper baffles (2) to the gripper connectors. Secure the baffles with provided screws. Adjust the lift of the baffles using the cable gripper.

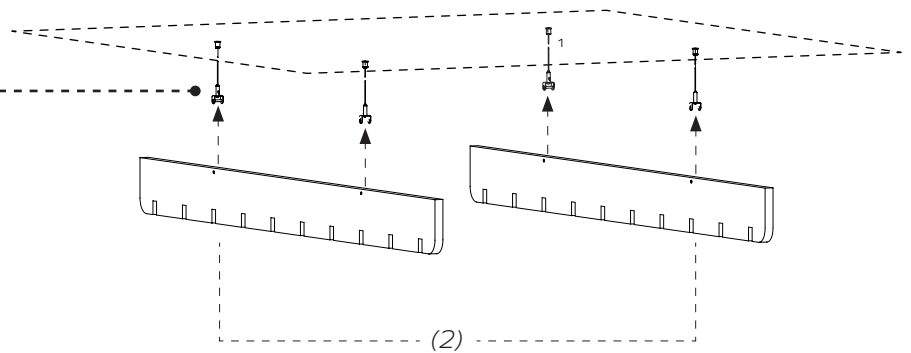

3 Install lower Baffles



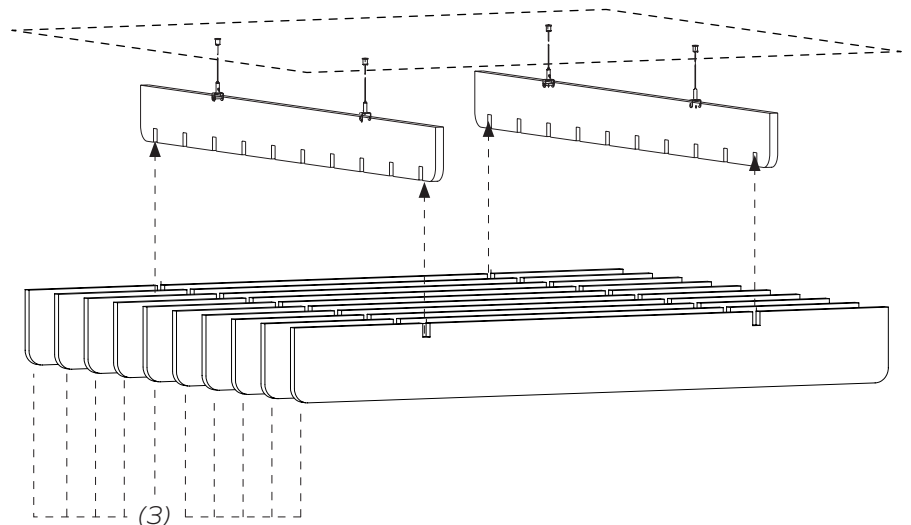





























Push in lower Baffles (3) into slots provided in a upper baffles.



ARCHISONIC®

Colors

 Material brochure available

								
Name	Snow White	Milk	Cloud	Smoke	Ground	Charcoal	Slate	Raven
Color Code	500	404	103	442	108	542	444	550
NCS Code	S 0300-N	S 0502-Y	S 1002-B	S 3005-R80B	S 5005-Y20R	S 7502-B	S 4500-N	S 8500-N
								
Name	Nordic Pine	Grove	Moss	Spearmint	Ice Blue	Succulent	Deep Sea	Marine Blue
Color Code	311	317	439	706	304	712	918	864
NCS Code	S 5030-G10Y	S 7020-G30Y	S 2040-G40Y	S 1010-B90G	S 0510-B	S 3020-B30G	S 5020-R90B	S 4050-R70B
								
Name	Linen	Shell Pink	Jute	Warm Stone	Terracotta	Soft Coral	Honeycomb	Sunshine
Color Code	107	102	920	105	239	516	139	846
NCS Code	S 1505-Y30R	S 0510-R30B	S 3010-Y30R	S 3010-Y50R	S 4040-Y70R	S 2020-Y90R	S 2050-Y20R	S 1040-Y10R
								
Name	Garnet	Hot Pink	Poster Red	Electric Orange	Winter Sky	Pacific Ocean	Midnight	Grape
Color Code	724	140	662	464	311	432	810	540
NCS Code	S 5040-R10B	S 2060-R20B	S 1080-R	S 0580-Y70R	S 5030-G10Y	S 3040-B	S 7020-R70B	S 5040-R40B

These NCS codes are the closest visual match available and may not be exact to blended fibres.

ARCHISONIC®

Colors

Experience our ARCHISONIC® Felt material with a stunning selection of 32 colors across 8 distinct families, thoughtfully curated by *Colour Hive* in London. Effortlessly combine colors harmoniously to suit your preferences. Discover more in our Materials brochure and order your free sample box today.

Color fastness

Class 6

ISO 105-B02:A1

Order a free sample box



ARCHISONIC® Felt

Material Specification

Product Name	Archisonic® Felt	
Content	100% PET (60% certified post-consumer content)	
Thickness¹	12mm (0.47")	24mm (0.94")
Max. Size	1200x2800mm (47"x110")	1800x2400mm (70"x94")
Acoustic²	ASTM: NRC=0.6 ISO: α_w =0.65	ASTM: NRC=0.9 ISO: α_w =0.95
Density¹	2400 g/m ² (0.49 lbs/ sqft)	4000 g/m ² (0.82 lbs/sqft)
Color Fastness	Class 6 ISO 105-B02:A1	
Color	32 colors (see Archisonic® Felt Color page for more information)	
Maintenance	For daily cleaning we recommend alcohol solution (75%), e.g. Pantasept. In case of contamination by dust or fluff, use feather duster or a regular vacuum cleaner. For heavy dirt, treat the material with hydrogen peroxide.	
Lead time³	21 days	
Fire Rating	DIN EN 13501-1: B-s1, d0	ASTM E84 Class A
VOC Emission	28 Days French Regulation A+ ASTM E84 Pass Bream® (International, UK, NL, SE, NOR) Exemplary CDPH (CDPH/EHLB/Standard Method V1.2) Pass	
Certifications	Declare label, Cradle to Cradle, UL Environmental Product Declaration, Member of US Green Building Council, Ecobau 1st Priority, Climmate-KIC, VOC emissions in LEED EQ credit (low-emitting products), SCS Recycled Content	
Durability	Contract	

1 - all values are nominal 2 - measured with 300mm air cavity 3 - depending on the location and type of product



Climate-KIC is supported by the EIT, a body of the European Union



Declare.



Nebula Modular Baffle

Acoustic Performance



Testing Standards

ISO 354:2003	Acoustics — Measurement of sound absorption in a reverberation room
ISO 11654:1997	Acoustics — Sound absorbers for use in buildings — Rating of sound absorption
ISO 20189:2018	Acoustics — Screens, furniture and single objects intended for interior use — Rating of sound absorption and sound reduction of elements based on laboratory measurements
ASTM C423-17	Standard Test Method for Sound Absorption and Sound Absorption Coefficients by the Reverberation Room Method
ASTM E795-16	Standard Practices for Mounting Test Specimens During Sound Absorption Tests

Acoustic Test Results

	α_w	SAA	NRC
Ceiling Baffle, 100mm height, 200mm spacing ¹	0.35 (H)	0.43	0.45
Ceiling Baffle, 200mm height, 200mm spacing ¹	0.7 (MH)	0.96	0.95
Ceiling Baffle, 100mm height, 300mm spacing ¹	0.3 (H)	0.32	0.30
Ceiling Baffle, 200mm height, 300mm spacing ¹	0.6 (MH)	0.72	0.70

1 - Measured with 200mm airgap between the slab and the panel

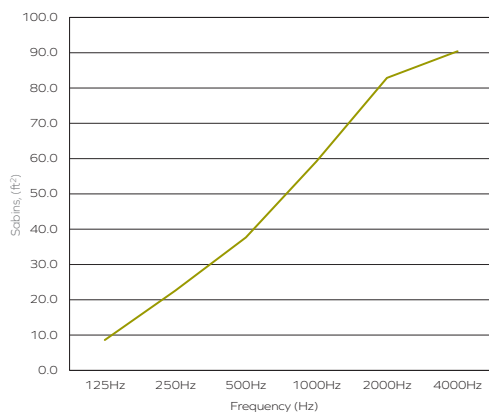

Acoustic Performance - ASTM Sabins, ft²

Frequency (Hz)	125	250	500	1000	2000	4000
Ceiling Baffle Standard Module 24mm	8.61	22.60	37.67	59.20	82.88	90.42

The graph represents the Sabins (ft²) in the third octave band center frequencies. Measurement used Pink Noise as excitation signal in a reverberant room.

● Ceiling Baffle Standard Module 24mm

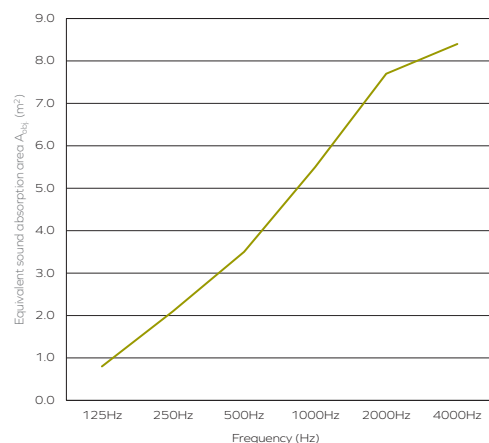

Acoustic Performance - ISO A_{obj}, m²

Frequency (Hz)	125	250	500	1000	2000	4000
Ceiling Baffle Standard Module 24mm	0.8	2.1	3.5	5.5	7.7	8.4

The graph represents the equivalent sound absorption per object (A_{obj}) in the third octave band center frequencies. Measurement used Pink Noise as excitation signal in a reverberant room.

● Ceiling Baffle Standard Module 24mm

Modular Baffle

Reference Projects



Nebula Modular Baffle

Additional Information

Online Resources

A variety of resources are available online for all of our products. Please visit the product's page for more information.



CAD files



Spec sheets and
Installation Guide



Color families



Instruction
videos



Associated
products specs.

Ordering Process

Our experienced team of Project Consultants will guide and support you throughout the order process. We fulfill the majority of our orders in as little as 21 days¹ from your first point of contact, allowing you to focus on what truly matters to you.



Contact our
consultant

Quote¹

48h



Order Confirmation

Production¹

14-21 days



Dispatch

Transit

location based



Delivery

Contact Us

Ready to make an impact? We are just an email or call away to discuss your project and answer any question.



+41 41 566 55 55



connect@impactacoustic.com



Online form

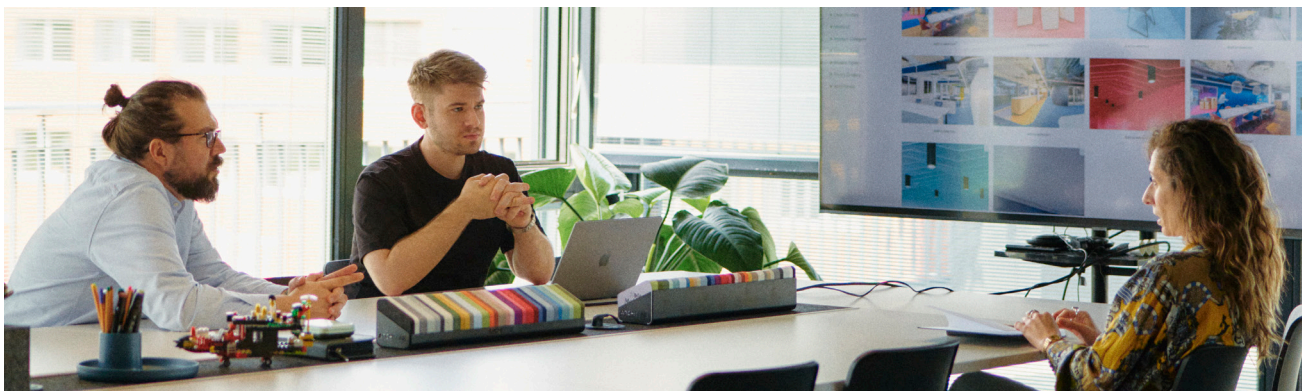

¹ - Quote and Production times may vary.

IMPACT ACOUSTIC®
Nebula Modular Baffle rev.01 - 16.01.24

(Switzerland)
(USA)
(Philippines)

connect@impactacoustic.com
usa@impactacoustic.com
philippines@impactacoustic.com

(+41) 41 566 55 55
(+1) 646 918 1581
(+63) 285 80 02 50

#WeMakeAnImpact

**#We
Make An
Impact**

connect@impactacoustic.com | www.impactacoustic.com