

# BUSTER+PUNCH

LONDON

[ product.

## **FORKED PENDANT / GLOBE**

---

[ type. **PENDANT LIGHT.** ]

---

[ detail. **FORKED.** ]

---

[ process. **ROUGH-CAST.** ]

---

[ region. **NORTH AMERICA.** ]

---

A light pendant made from cast and machined metal, featuring our signature diamond-cut linear knurl pattern and fork detailing, refined by hand. It comes with a handblown glass globe.



[ size. **MEDIUM.** ]

[ info. **MEASUREMENTS.** ]

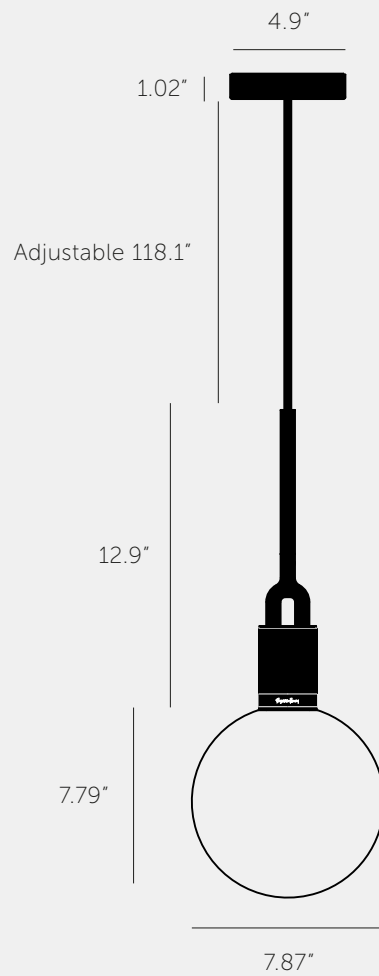

[ info. **SPECIFICATIONS.** ]

Pendant light

1x solid metal lamp holder

Adjustable 3000 mm cable

E26 / 110-120 VAC / 60HZ

Max 7W

Bulb included

cULus Listed SBLED













1x medium hand-blown glass globe

E26 compatible

[ info. **FINISH & SKU NUMBERS.** ]

[ finish. ]

[ SKU. ]

 	Steel / Opal	NFP-843179
 	Brass / Opal	NFP-823169
 	Gun Metal / Opal	NFP-873189
 	Steel / Smoked	NFP-853181
 	Brass / Smoked	NFP-493171
 	Gun Metal / Smoked	NFP-883191

[ info. **CARE INSTRUCTIONS.** ]

Wipe with damp cloth with no loose hairs, avoid using any chemicals. All finishes are prone to ageing.

[ please. **NOTE.** ]

DISCLAIMER: Always consult a trade professional when installing this light. Buster + Punch is not responsible for the usage or feasibility of installation requirements. This product is not suitable for damp or wet environments.

[ size. **LARGE.** ]

[ info. **MEASUREMENTS.** ]

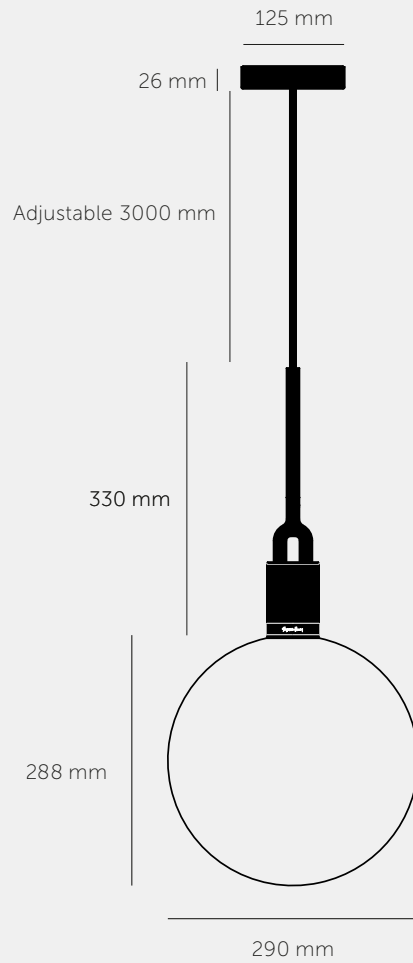

[ info. **SPECIFICATIONS.** ]

Pendant light

1x solid metal lamp holder

Adjustable 3000 mm cable

E26 / 110-120 VAC / 60HZ

Max 7W

Bulb included

cULus Listed SBLED











1x large hand-blown glass globe

E26 compatible

[ info. **FINISH & SKU NUMBERS.** ]

[ finish. ]

[ SKU. ]

 	Steel / Opal	NFP-843180
 	Brass / Opal	NFP-823170
 	Gun Metal / Opal	NFP-873190
 	Steel / Smoked	NFP-853182
 	Brass / Smoked	NFP-493172
 	Gun Metal / Smoked	NFP-883192

[ info. **CARE INSTRUCTIONS.** ]

Wipe with damp cloth with no loose hairs, avoid using any chemicals. All finishes are prone to ageing.

[ please. **NOTE.** ]

DISCLAIMER: Always consult a trade professional when installing this light. Buster + Punch is not responsible for the usage or feasibility of installation requirements. This product is not suitable for damp or wet environments.