

Bespoke

Straight Grid Ceiling

715.24.10.000.80
715.24.20.000.80
715.24.10.000.90
715.24.20.000.90

715.24.11.000.80
715.24.21.000.80
715.24.11.000.90
715.24.21.000.90

715.12.10.000.00
715.12.20.000.00

Bespoke Straight Grid Ceiling

General Information

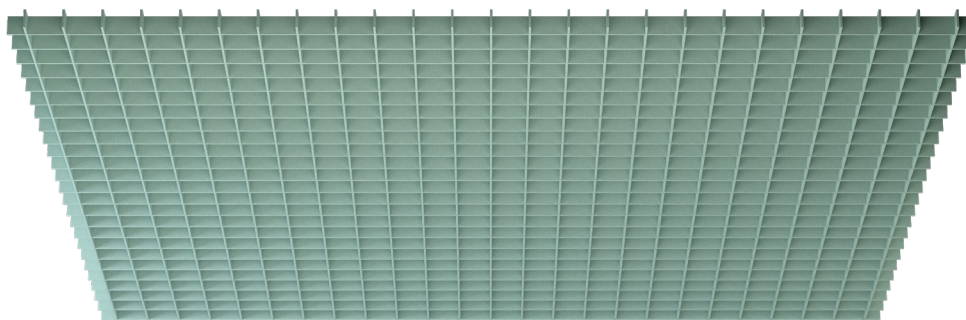

Data

Applicable article numbers

715.24.10.000.80	715.24.11.000.80	715.24.10.000.90	715.24.11.000.90
715.24.20.000.80	715.24.21.000.80	715.24.20.000.90	715.24.21.000.90
715.12.10.000.00	715.12.20.000.00		

Dimensions¹

Height	200mm	7.87"
Grid Spacing	400mm or 600mm	15.75" or 23.62"
Material thickness	24mm	0.94"
Area	on demand	on demand

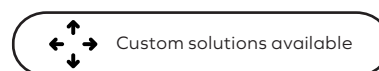

1 - all Imperial dimensions are nominal

Material

Grid	100% PET (60% post-consumer) in 32 colors.
Strut profiles	Steel (galvanized or powder coated black)

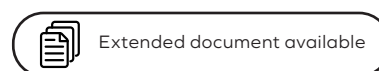

Weight²

PET material	4kg/m ² (±10%)	0.82 lbs/ft ² (±10%)
Strut profile	0.62kg/m	0.99 lbs/ft

2 - all weight values are nominal

Included

Grid Panels

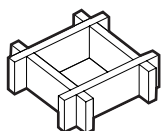

Suspension system



Installation guide



Design revision



Warranty 2 years³



1 - all dimensions are nominal 2 - all weight values are nominal 3 - Impact Acoustic warranty terms apply

Bespoke Straight Grid Ceiling

Specification Guide

Ensure you make the perfect choice by choosing our solutions for your next project. To get started, simply define some basic information and constraints about your space. Then explore our range of standard solutions or contact us directly for a more in-depth discussion of personalised customized options.

1 Prepare this information:

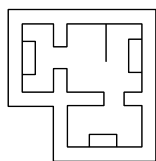

Projectgebiet

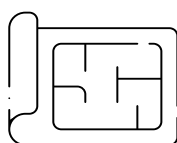

Deckenpläne (RCP)

Seite 8



Other Considerations

Seite 8

2 Specify your Baffles:

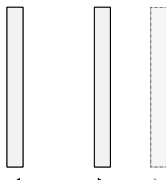

Abstände

Seite 4

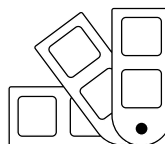

Farbe

Seite 10

3 Select installation method:

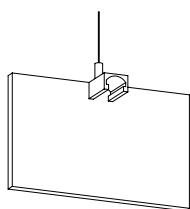

Strebenbahn

Seite 5,7

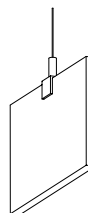

Direkter Greifer

Seite 6,8

Bespoke Straight Grid Ceiling

Geometry Information



Reference geometry

Explore the various standard and custom sizes in our product families. See the drawing below for an overview of basic dimensions, modules and ranges.

Customize our **Bespoke** products beyond the presented values - contact us for details.

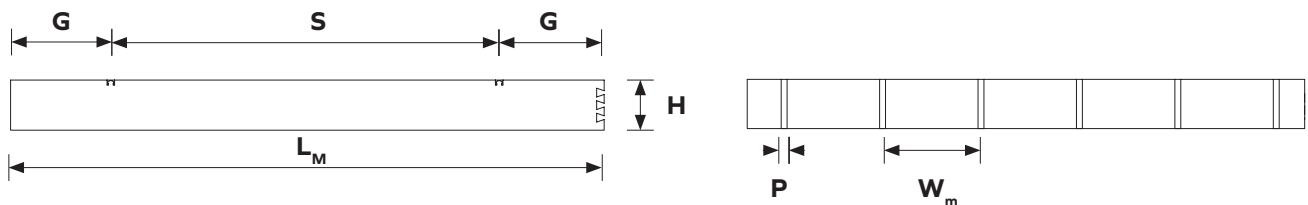
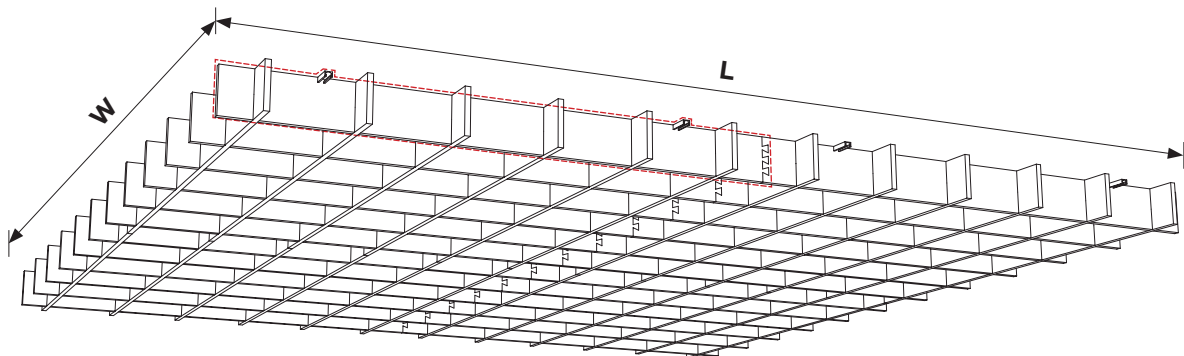

Dimensions table

W	Total width	on demand	on demand	<i>bespoke</i>
L	Total length	on demand	on demand	<i>bespoke</i>
W_m	Spacing	400 or 600mm	15.75" or 23.62"	<i>standard or bespoke</i>
L_m	Length module	1600-2400mm	63"-94.5"	<i>standard</i>
G	Overhang	400mm	15.75"	<i>standard</i>
S	Support spacing	max.1600	max.63"	<i>standard</i>
H	Baffle height	200mm	7.87"	<i>standard or bespoke</i>
P	PET material thickness	24mm	0.94"	<i>fixed</i>

Bespoke Straight Grid Ceiling

Product Family Overview

1 Bespoke Grid Ceiling 400x400 (Strut Mount)



Customizable product

715.24.10.000.80 - Bespoke Grid Ceiling (H200, S400) (H7.87", S15.75")

715.24.11.000.80 - Bespoke Grid Ceiling Infill (H200, S400) (H7.87", S15.75")

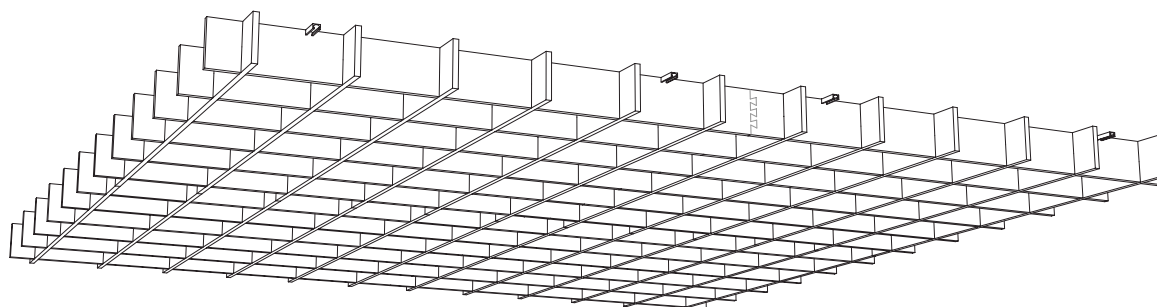

2 Bespoke Grid Ceiling 600x600 (Strut Mount)



Customizable product

715.24.21.000.80 - Bespoke Grid Ceiling (H200, S600) (H7.87", S23.62")

715.24.22.000.80 - Bespoke Grid Ceiling Infill (H200, S600) (H7.87", S23.62")

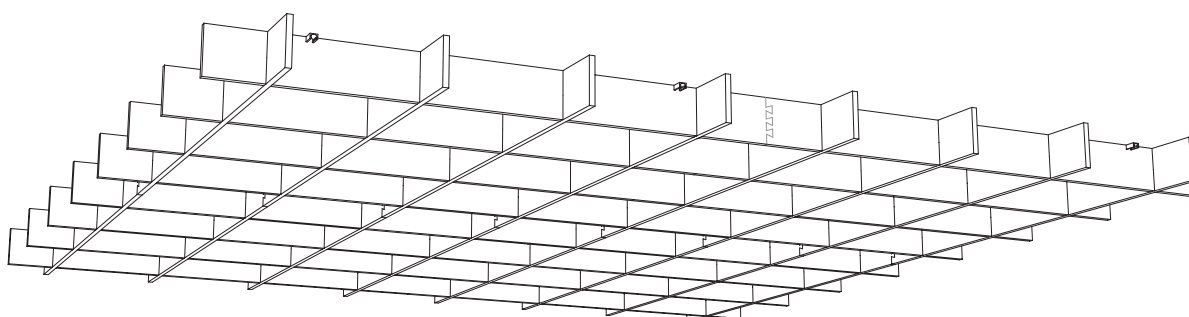

Bespoke Straight Grid Ceiling

Extended document available

Installation Overview Strut

1 Verify and organize

Verify all delivered elements and organize them based on the included labeling of each part and the supplied drawings.

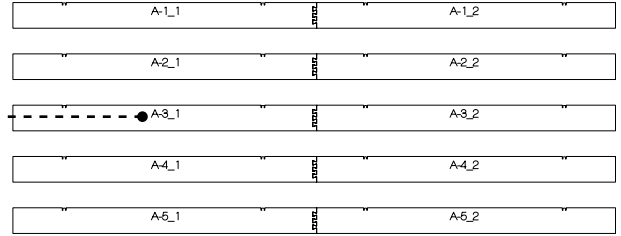
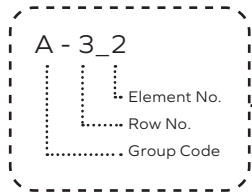

2 Install mounting hardware

Measure, mark and fix suspension hardware to your ceiling.

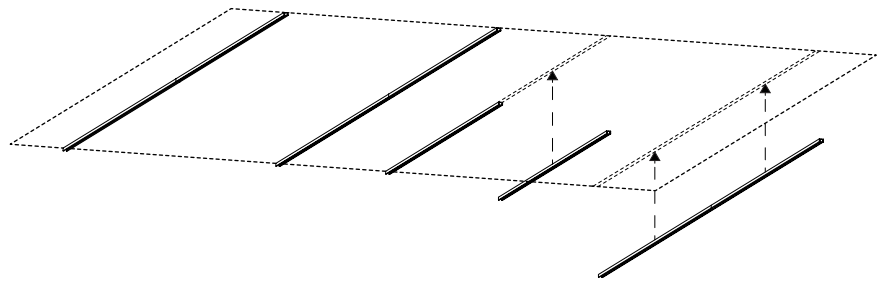

3 Install upper segments

Fix segments to mounting hardware and connect them together using the dovetail joints.

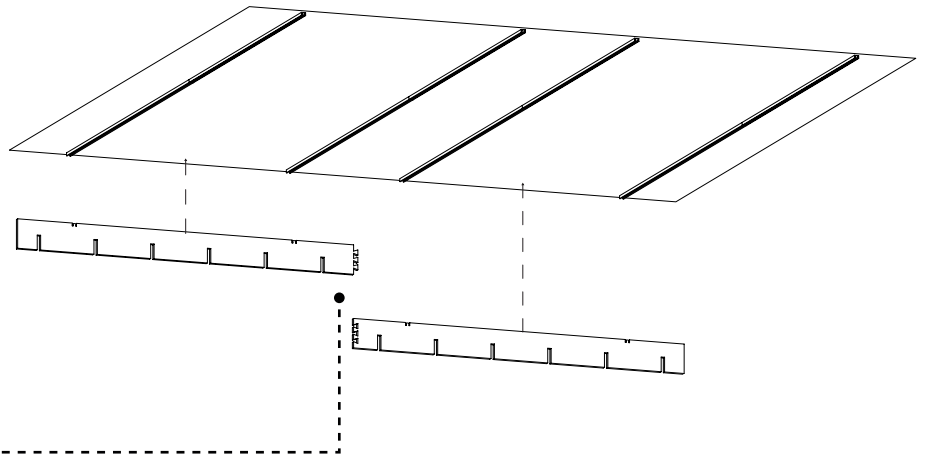
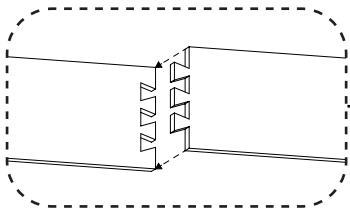

4 Install lower segments

Slot in lower segments into previously installed upper segments in perpendicular direction and connect dovetails.

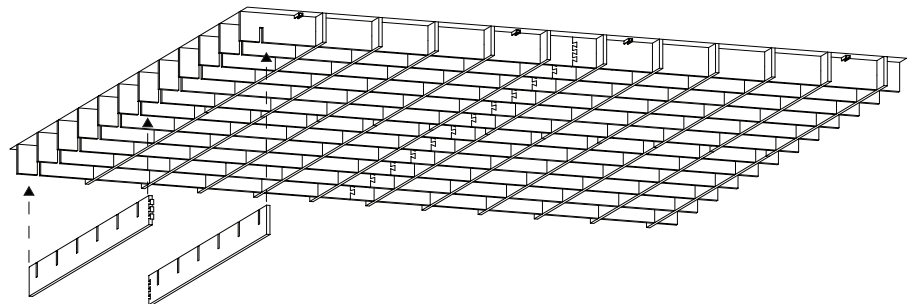

Bespoke Straight Grid Ceiling

 Extended document available

Installation Overview

1 Verify and organize

Verify all delivered elements and organize them based on the included labeling of each part and the supplied drawings.

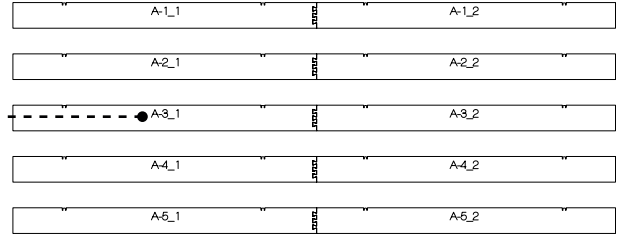
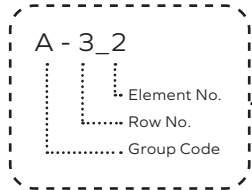

2 Install mounting hardware

Measure, mark and fix suspension hardware to your ceiling.

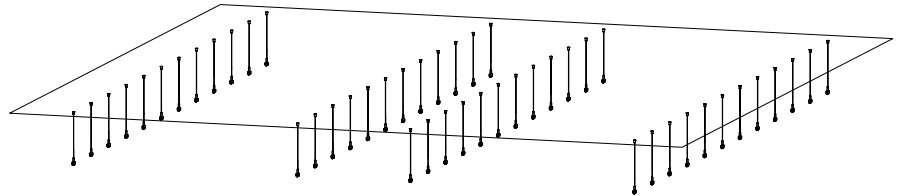

3 Install upper segments

Fix segments to mounting hardware and connect them together using the dovetail joints.

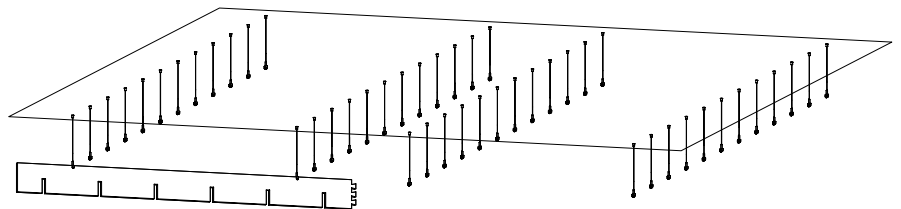
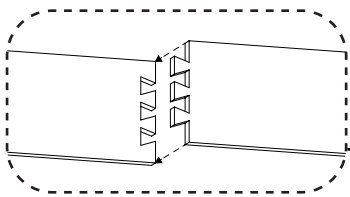

4 Install lower segments

Slot in lower segments into previously installed upper segments in perpendicular direction and connect dovetails.

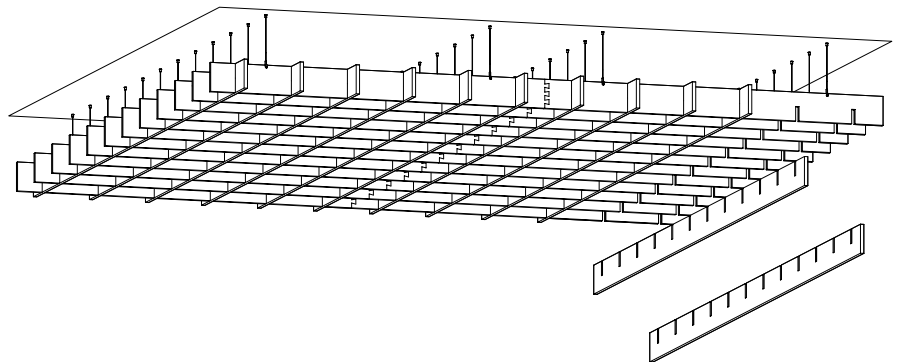

Bespoke Straight Grid Ceiling

Optional Infill Cells

The rectangular cells in our Bespoke Grid Ceiling System can be optionally closed from the top side with additional piece of PET material with or without integrated spot light. The distribution and percentage of enclosed cells as well as the about of light spots can be customized on request.

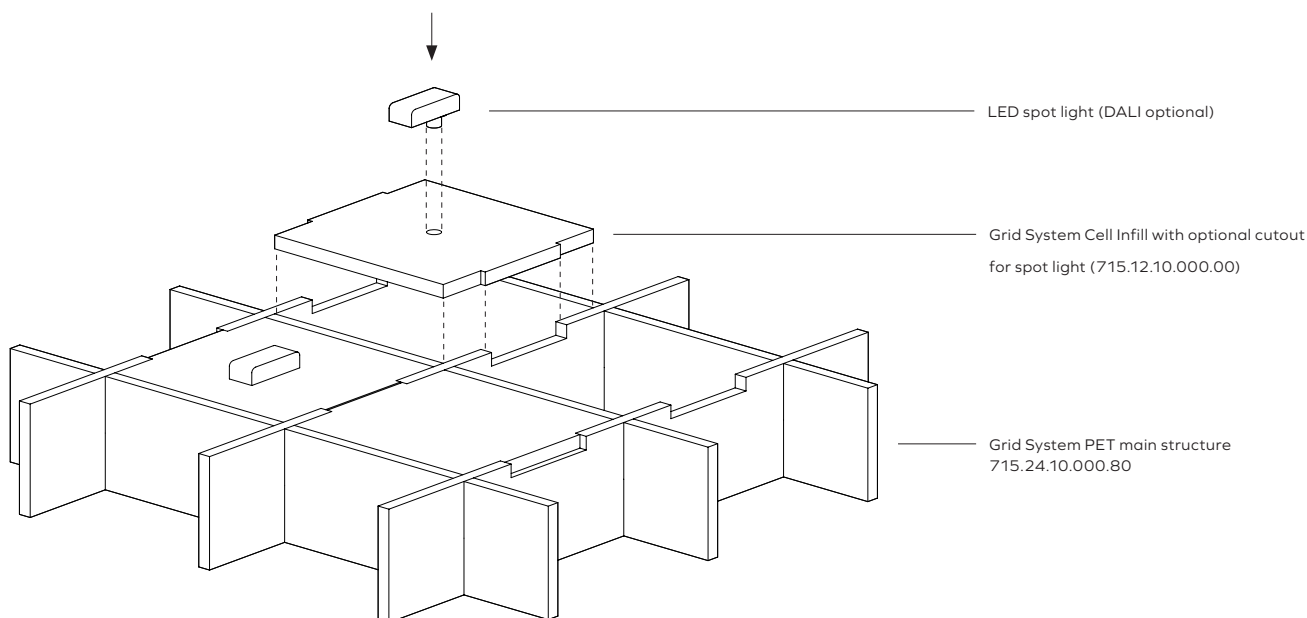

LIGHTING SPECIFICATIONS

per spot light

Output	Direct Only
Total Lumen Output (lm)	328
Wattage	6.5
Efficacy (lm/W)	50.5
Diffuser	Lens
Beam Angle	34
CCT	2700-3000-3500-4000K
CRI	90+
MacAdam	3
Dimming (optional)	0-10V 0.1% DSI/DALI
Driver Location	On-Board

LIGHT DISTRIBUTION GRAPH

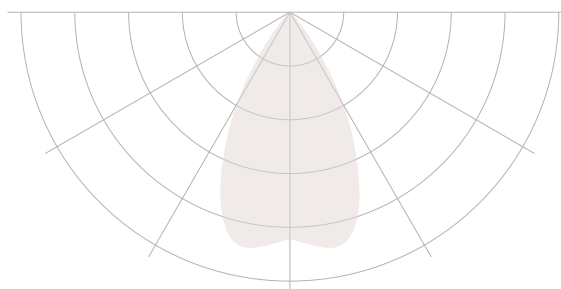

CERTIFICATIONS



Bespoke Straight Grid Ceiling

Infill Cells Overview

1 Grid Infill Cell 400x400 (with or without light)

715.12.10.000.00 - Grid Infill Cell 400

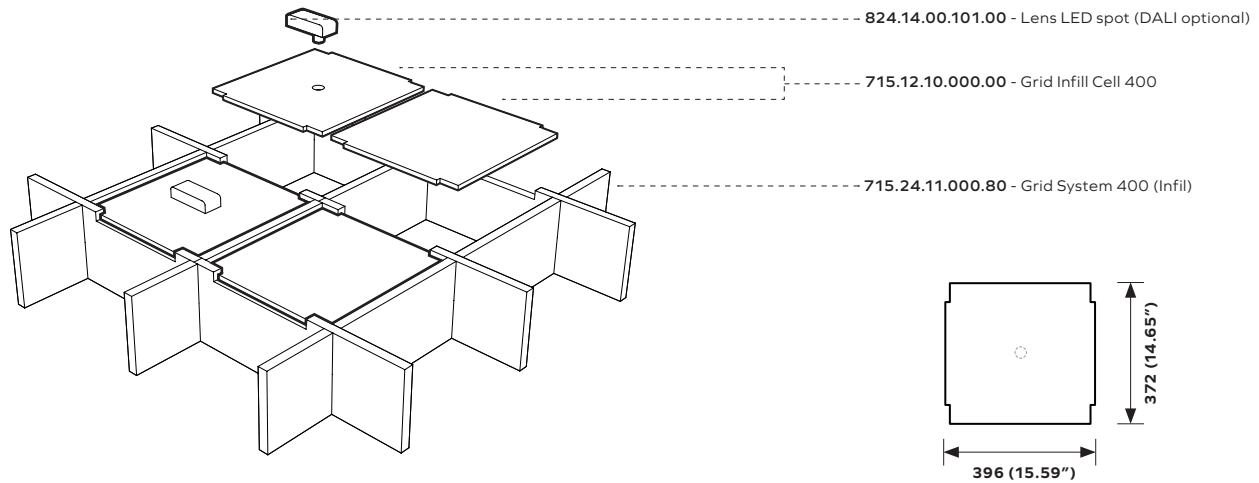

2 Grid Infill Cell 600x600 (with or without light)

715.12.20.000.00 - Bespoke Grid Ceiling

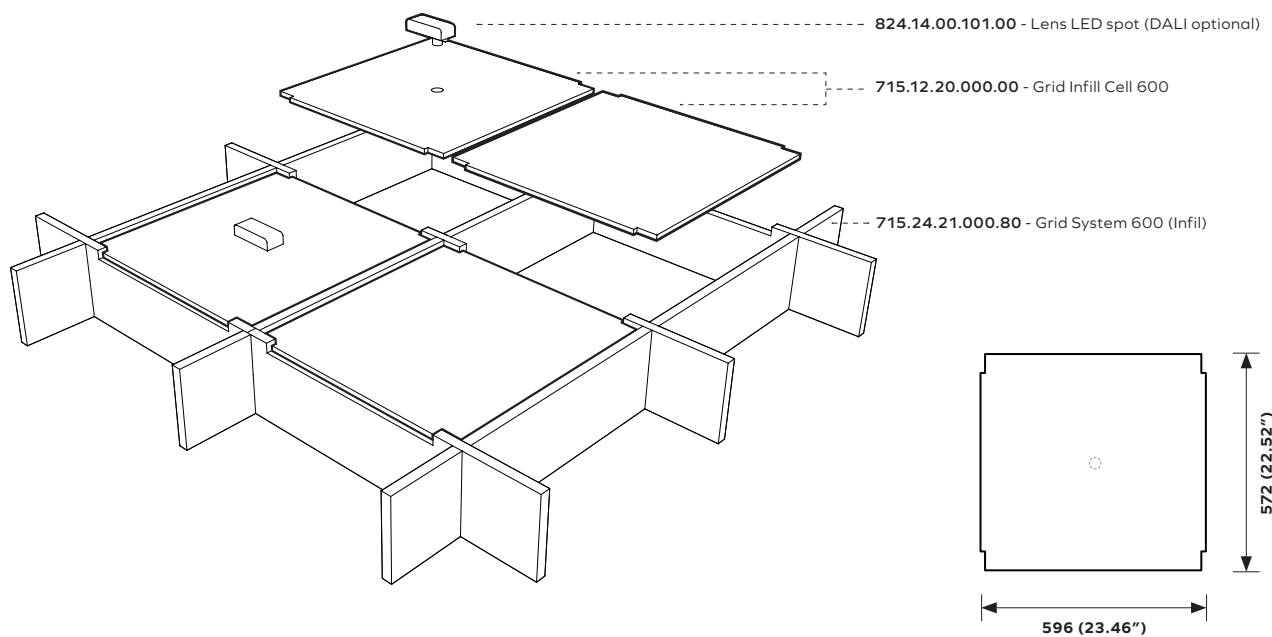

Bespoke Straight Grid Ceiling

Planning Considerations

 Extended document available

When planning the addition of a Bespoke Ceiling Baffle System to your space, please consider the following aspects.

1 Project Area

Check and verify the project area where the Ceiling Grid System will be installed. This will allow us to provide you with an accurate quote.

2 Reverse Ceiling Plans

Verify if RCP drawings for the space are available. This will help plan for any obstacles like columns and air-ducts that might collide with the Grid elements.

3 Additional considerations

Consider access to high windows and doors.

Verify the type of material to which the support elements will be mounted.

Plan for providing min. 100mm (4") safe space distance from Grid to other elements

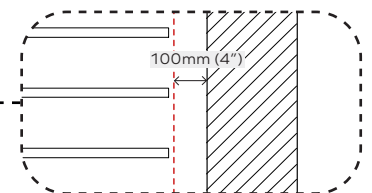

Consider possible cutouts for the air ducts and columns..

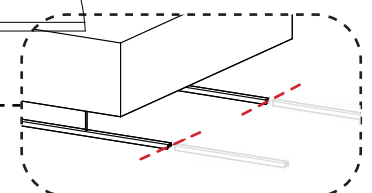
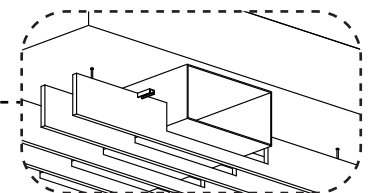

The provided strut tracks might need to be cut to measure on site.

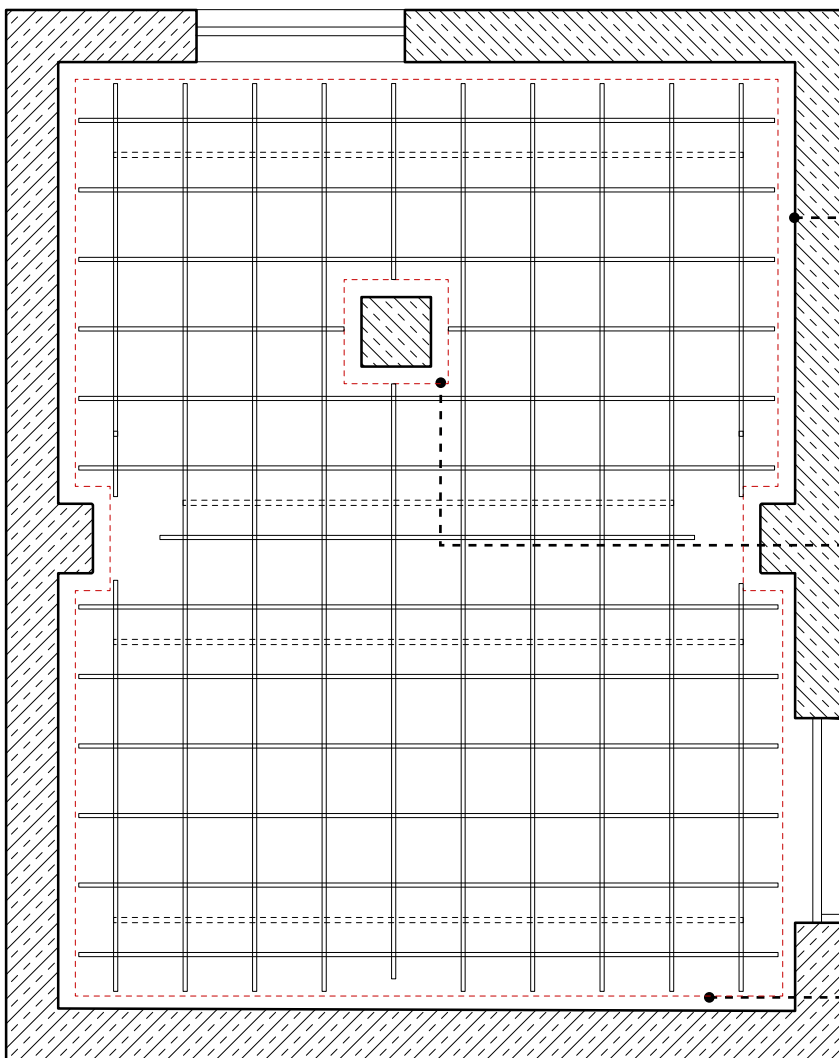

RCP drawing example

ARCHISONIC®

Colors

 Material brochure available



Name	Snow White	Milk	Cloud	Smoke	Ground	Charcoal	Slate	Raven
Color Code	500	404	103	442	108	542	444	550
NCS Code	S 0300-N	S 0502-Y	S 1002-B	S 3005-R80B	S 5005-Y20R	S 7502-B	S 4500-N	S 8500-N



Name	Nordic Pine	Grove	Moss	Spearmint	Ice Blue	Succulent	Deep Sea	Marine Blue
Color Code	311	317	439	706	304	712	918	864
NCS Code	S 5030-G10Y	S 7020-G30Y	S 2040-G40Y	S 1010-B90G	S 0510-B	S 3020-B30G	S 5020-R90B	S 4050-R70B



Name	Linen	Shell Pink	Jute	Warm Stone	Terracotta	Soft Coral	Honeycomb	Sunshine
Color Code	107	102	920	105	239	516	139	846
NCS Code	S 1505-Y30R	S 0510-R30B	S 3010-Y30R	S 3010-Y50R	S 4040-Y70R	S 2020-Y90R	S 2050-Y20R	S 1040-Y10R



Name	Garnet	Hot Pink	Poster Red	Electric Orange	Winter Sky	Pacific Ocean	Midnight	Grape
Color Code	724	140	662	464	311	432	810	540
NCS Code	S 5040-R10B	S 2060-R20B	S 1080-R	S 0580-Y70R	S 5030-G10Y	S 3040-B	S 7020-R70B	S 5040-R40B

These NCS codes are the closest visual match available and may not be exact to blended fibres.

ARCHISONIC®

Colors

Experience our ARCHISONIC® Felt material with a stunning selection of 32 colors across 8 distinct families, thoughtfully curated by *Colour Hive* in London. Effortlessly combine colors harmoniously to suit your preferences. Discover more in our Materials brochure and order your free sample box today.

Color fastness

Class 6

ISO 105-B02:A1

Order a free sample box



ARCHISONIC® Felt

Material Specification

Product Name	Archisonic® Felt	
Content	100% PET (60% certified post-consumer content)	
Thickness¹	12mm (0.47")	24mm (0.94")
Max. Size	1200x2800mm (47"x110")	1800x2400mm (70"x94")
Acoustic²	ASTM: NRC=0.6 ISO: αw=0.65	ASTM: NRC=0.9 ISO: αw=0.95
Density¹	2400 g/m ² (0.49 lbs/ sqft)	4000 g/m ² (0.82 lbs/sqft)
Color Fastness	Class 6 ISO 105-B02:A1	
Color	32 colors (see Archisonic® Felt Color page for more information)	
Maintenance	For daily cleaning we recommend alcohol solution (75%), e.g. Pantasept. In case of contamination by dust or fluff, use feather duster or a regular vacuum cleaner. For heavy dirt, treat the material with hydrogen peroxide.	
Lead time³	21 days	
Fire Rating	DIN EN 13501-1: B-s1, d0	ASTM E84 Class A
VOC Emission	28 Days French Regulation A+ ASTM E84 Pass Bream® (International, UK, NL, SE, NOR) Exemplary CDPH (CDPH/EHLB/Standard Method V1.2) Pass	
Certifications	Declare label, Cradle to Cradle, UL Environmental Product Declaration, Member of US Green Building Council, Ecobau 1st Priority, Climmate-KIC, VOC emissions in LEED EQ credit (low-emitting products), SCS Recycled Content	
Durability	Contract	

1 - all values are nominal 2 - measured with 300mm air cavity 3 - depending on the location and type of product



Climate-KIC is supported by the EIT, a body of the European Union



Declare.

DANAK
TEST Reg.nr. 522



Bespoke Straight Grid Ceiling

Acoustic Performance



Testing Standards

ISO 354:2003	Acoustics — Measurement of sound absorption in a reverberation room
ISO 11654:1997	Acoustics — Sound absorbers for use in buildings — Rating of sound absorption
ISO 20189:2018	Acoustics — Screens, furniture and single objects intended for interior use — Rating of sound absorption and sound reduction of elements based on laboratory measurements
ASTM C423-17	Standard Test Method for Sound Absorption and Sound Absorption Coefficients by the Reverberation Room Method
ASTM E795-16	Standard Practices for Mounting Test Specimens During Sound Absorption Tests

Acoustic Test Results

	α_w	SAA	NRC
Ceiling Grid, 200mm height, 400mm spacing, with inlay	1.00	1.04	1.05
Ceiling Grid, 200mm height, 400mm spacing, without inlay	0.50 (MH)	0.67	0.65

Acoustic Performance

Frequency (Hz)		125	250	500	1000	2000	4000
Ceiling Grid, 200mm height, 400mm spacing, with inlay	α_{pi}	0.35	0.85	0.95	1.00	1.00	1.00
Ceiling Grid, 200mm height, 400mm spacing, without inlay	α_{pi}	0.10	0.30	0.45	0.80	1.00	1.00

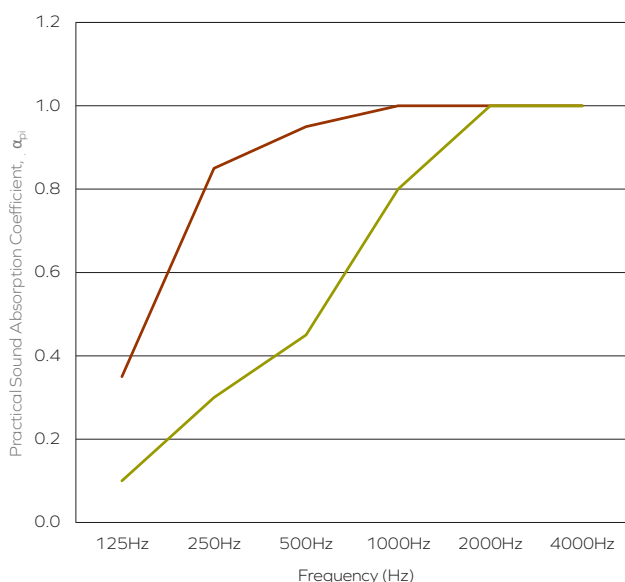

- Ceiling Grid, 200mm height, 400mm spacing, with inlay
- Ceiling Grid, 200mm height, 400mm spacing, without inlay

The graph represents the sound absorption coefficients (α_s) in the third octave band center frequencies. Measurement used Pink Noise as excitation signal in a reverberant room.

Bespoke Straight Grid Ceiling

Additional Information

Online Resources

A variety of resources are available online for all of our products. Please visit the product's page for more information.



CAD files



Spec sheets and
Installation Guide



Color families



Instruction
videos



Associated
products specs.

Ordering Process

Our experienced team of Project Consultants will guide and support you throughout the order process. We fulfill the majority of our orders in as little as 21 days¹ from your first point of contact, allowing you to focus on what truly matters to you.



Contact our
consultant

Quote¹

48h



Order Confirmation

Production¹

14-21 days



Dispatch

Transit

location based



Delivery

Contact Us

Ready to make an impact? We are just an email or call away to discuss your project and answer any question.



+41 41 566 55 55



connect@impactacoustic.com



Online form

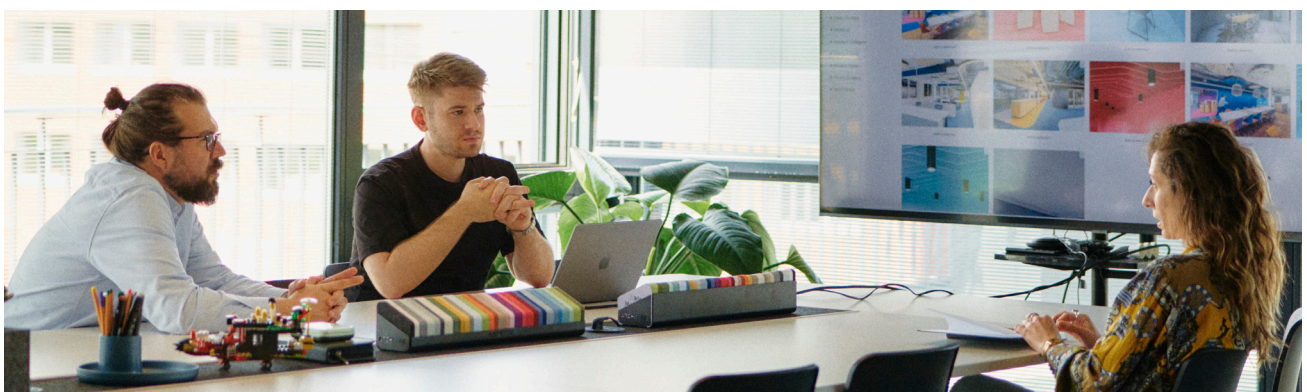

¹ - Quote and Production times may vary.

IMPACT ACOUSTIC®
Bespoke Grid Ceiling rev.01 - 17.01.24

(Switzerland)
(USA)
(Philippines)

connect@impactacoustic.com
usa@impactacoustic.com
philippines@impactacoustic.com

(+41) 41 566 55 55
(+1) 646 918 1581
(+63) 285 80 02 50

#WeMakeAnImpact

**#We
Make An
Impact**

connect@impactacoustic.com | www.impactacoustic.com